

VERTICAL ACTION

MG5

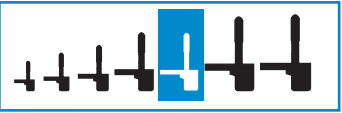

Material: Heavy gauge steel
 Hardened pins and bushes

Finishing: Zinc Plated

Supplied with: 10x80mm spindles

Max Holding pressure: 360daN close to body

Weight: 0.68Kgs

Clamping pressure:

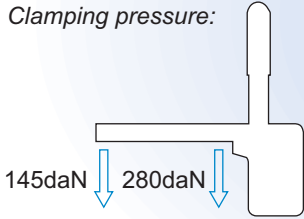

MOUNTING PLATE

See accessories page for details

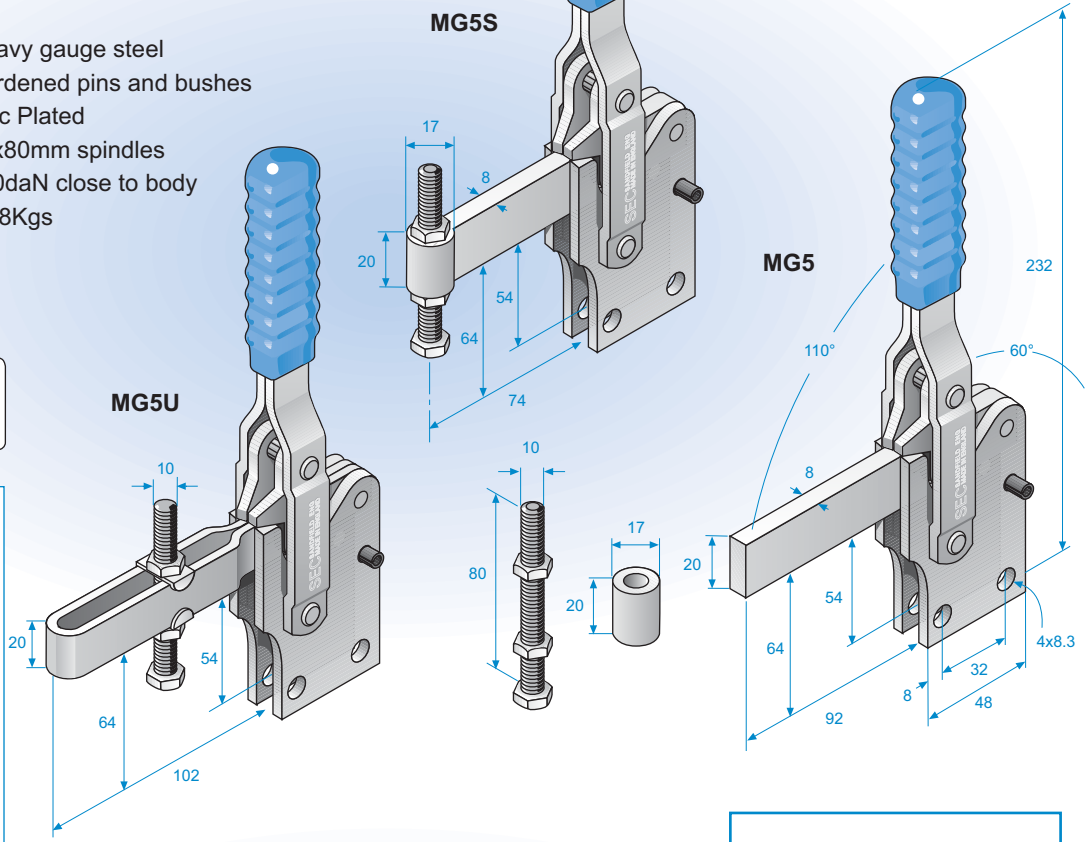
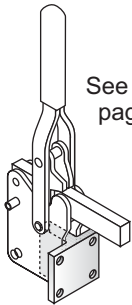

MG5B

T-HANDLE

MG5--T

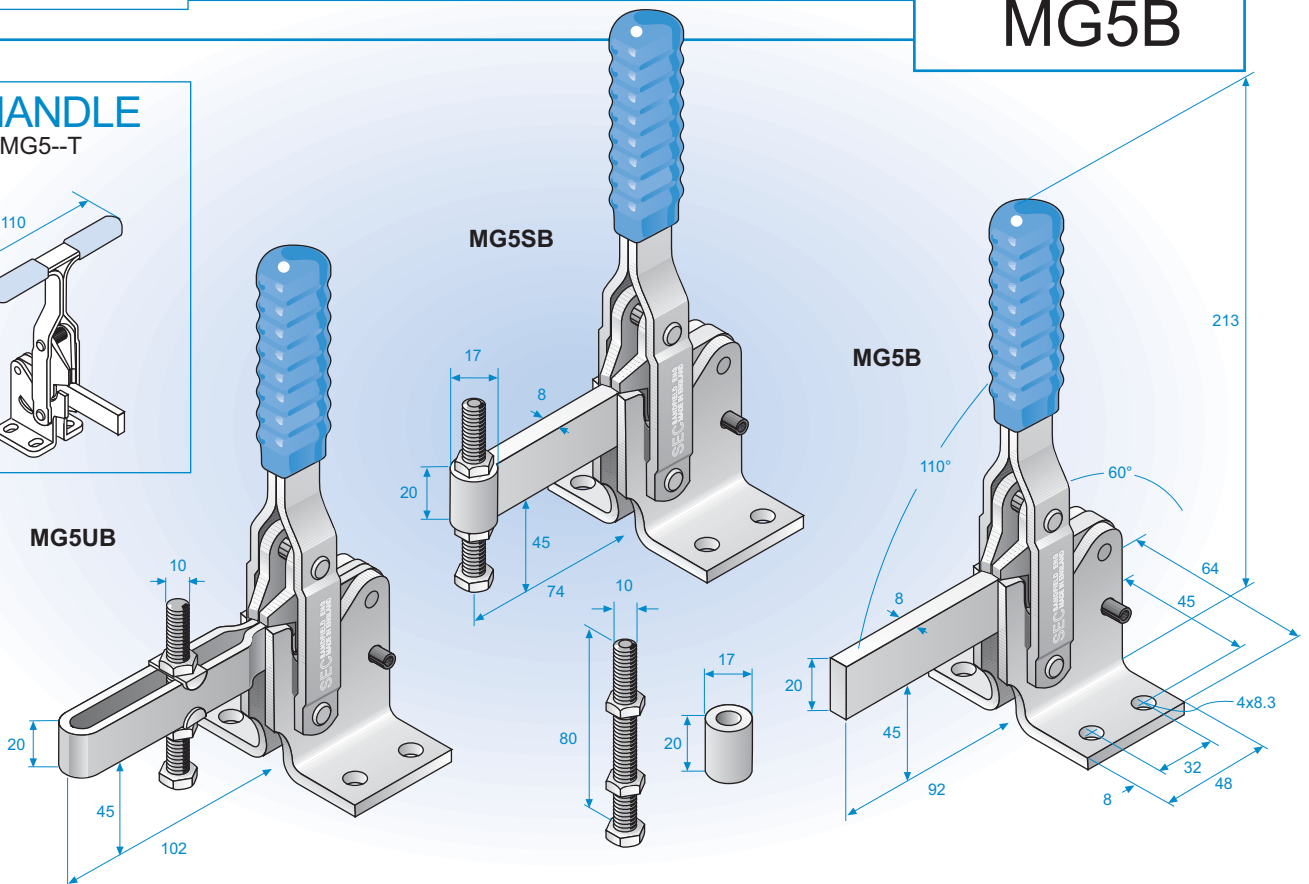
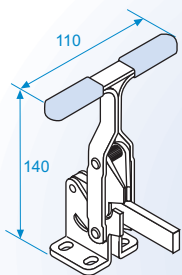

Refer to accessory pages for further information