

# VERTICAL ACTION

# MG5

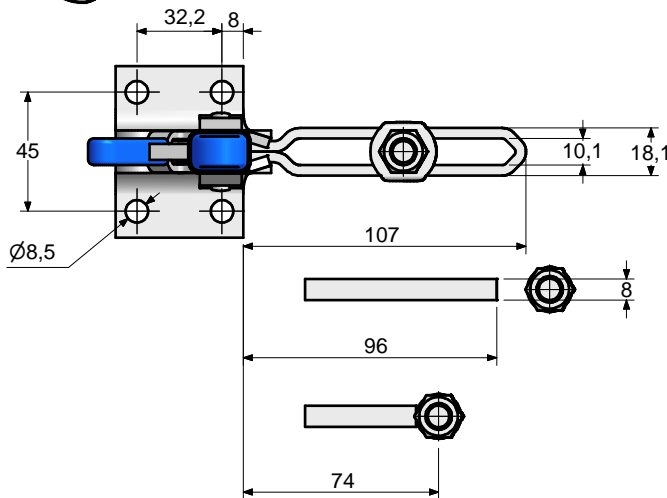

**Material:** Heavy gauge steel  
**Finish:** Zinc plated  
**Supplied with:** M10x80mm spindle  
**Max holding force:** 360daN  
**Weight:** 0.69Kgs  
**Clamping pressure:**

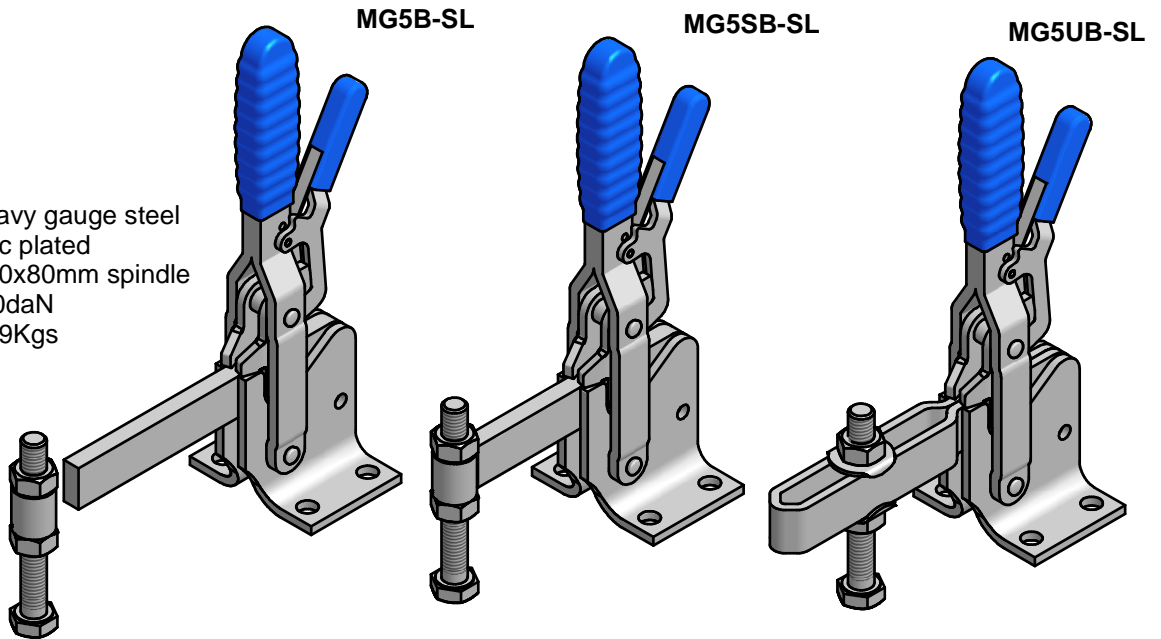
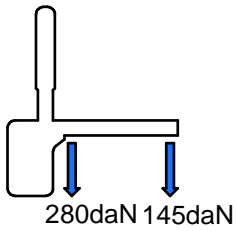

MG5UB-SL

MG5B-SL

MG5SB-SL

