

HORIZONTAL ACTION

MH1

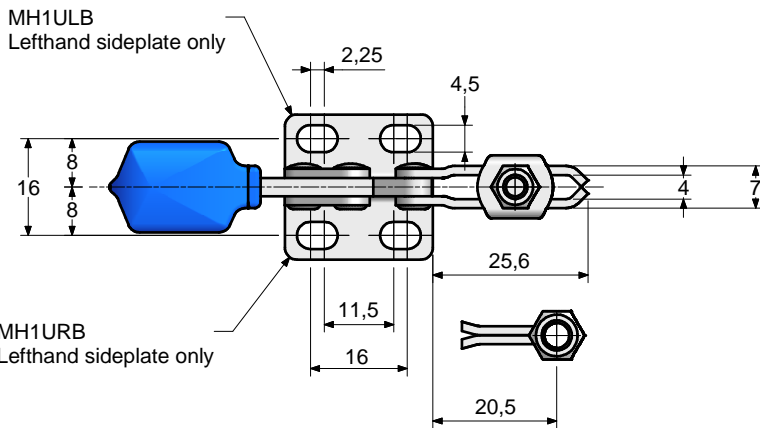

Material: Heavy gauge steel
Finish: Zinc plated
Supplied with: MH1SB M5x25mm spindle
 MH1UB M4x25mm spindle
 MH1ULB M4x25mm spindle
 MH1URB M4x25mm spindle
Max holding force: 60daN
Weight: 0.05Kgs
Clamping pressure:

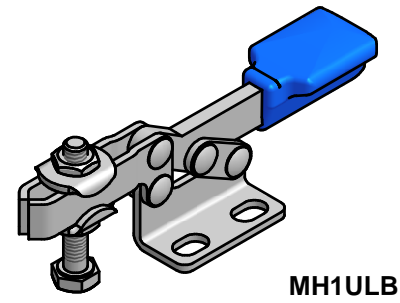
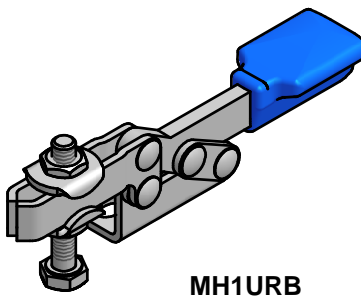
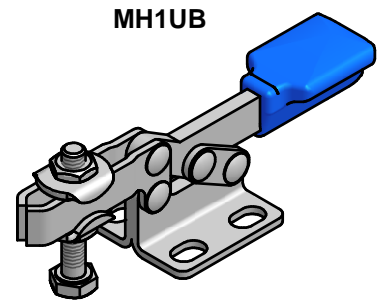
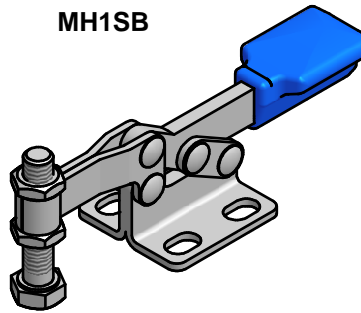
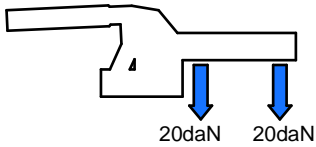

MH1UB
 MH1ULB
 MH1URB

MH1SB

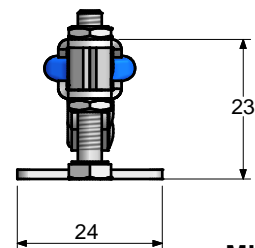
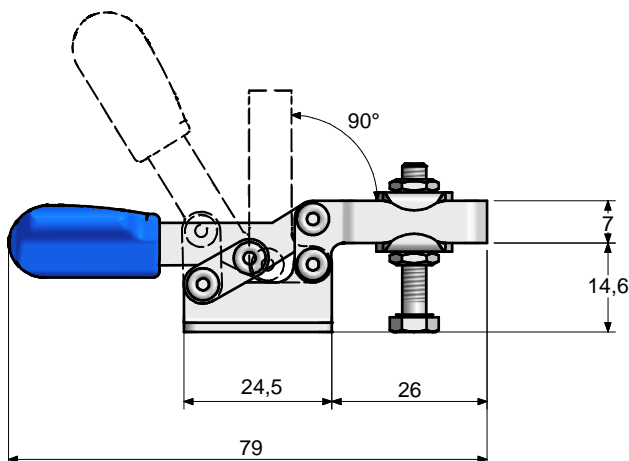

MH1UBSS
 Stainless steel
 option available