

PLUNGER ACTION

CP75

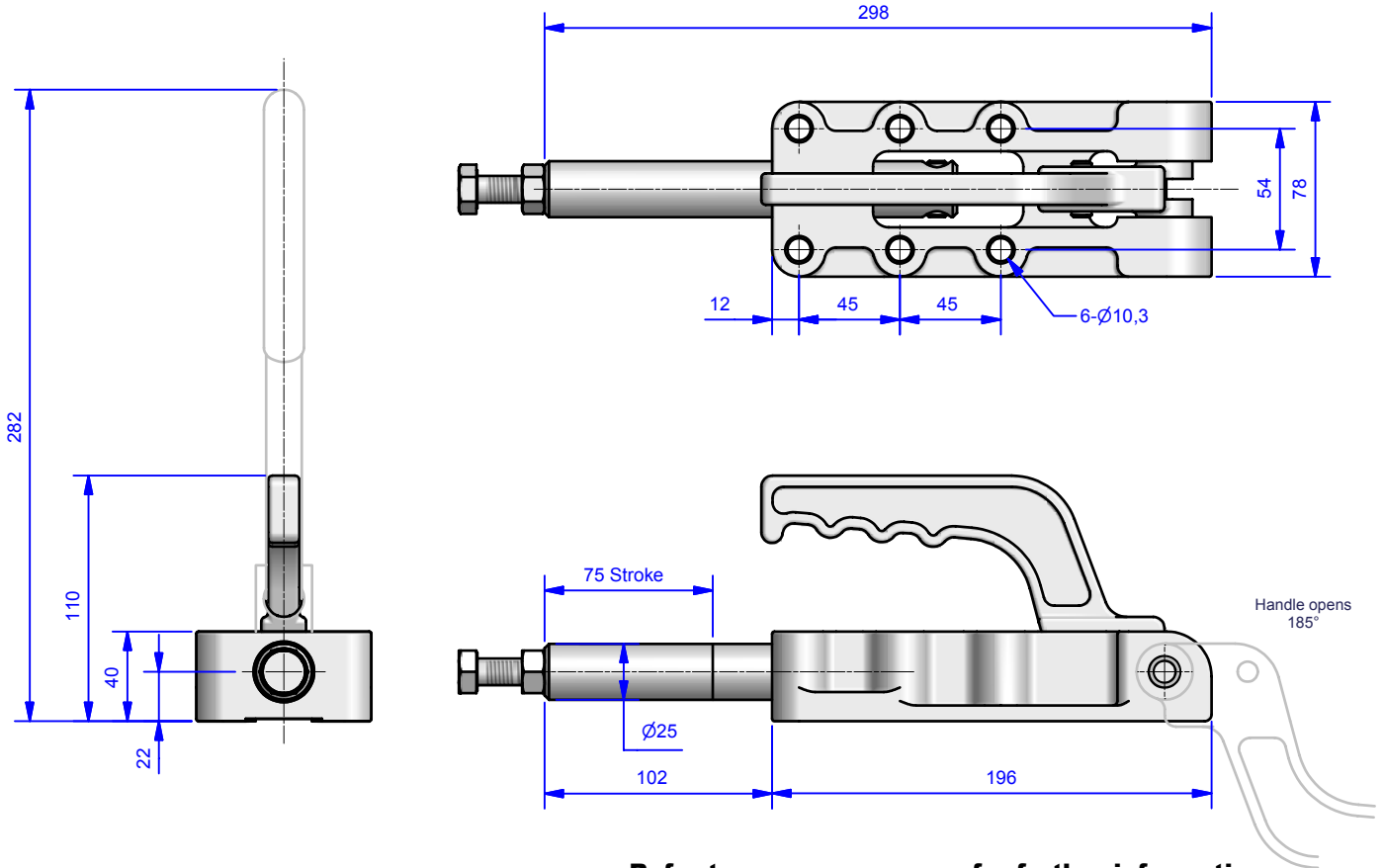

Material: Heavy gauge steel
 Hardened pins and bushes
Finishing Chemi blacked
Supplied with: 12x50mm spindle
Max Holding pressure: 2500daN
Weight: 3.7kg - CP75
 4.2kg - CP75/90

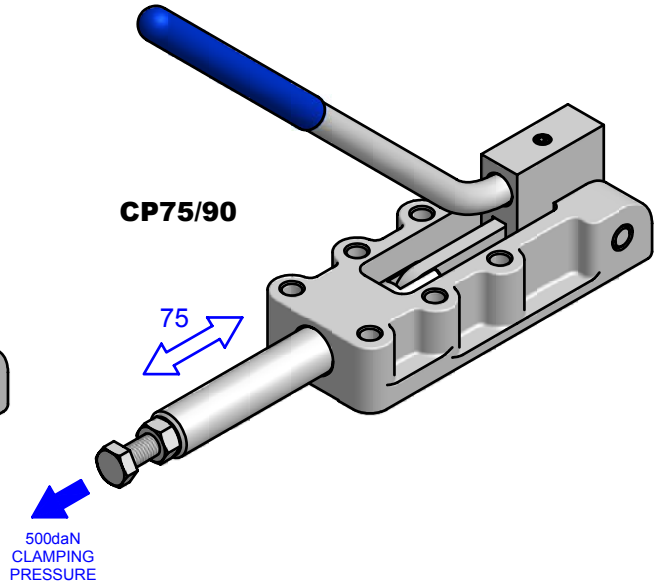
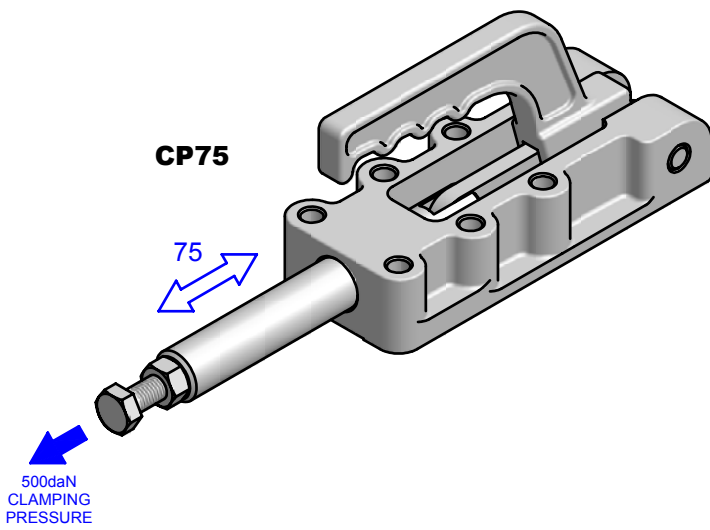

Refer to accessory pages for further information