

HOOK CLAMP

HC03

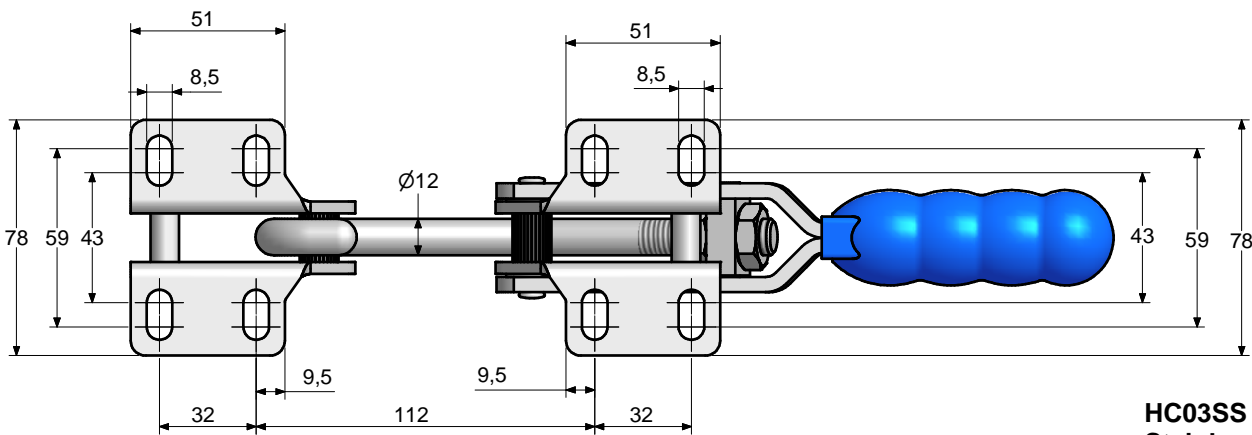

Material: Heavy gauge steel
Finish: Zinc Plated
Supplied with: Hook, Latch plate
Max holding force: 680daN
Weight: 0.85Kgs
Clamping pressure:

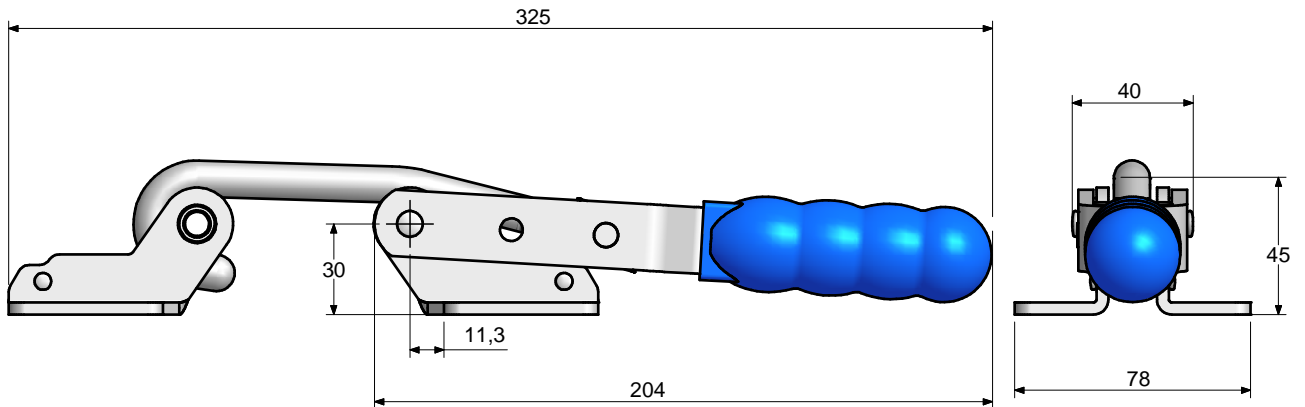
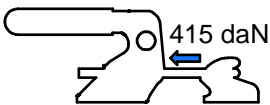
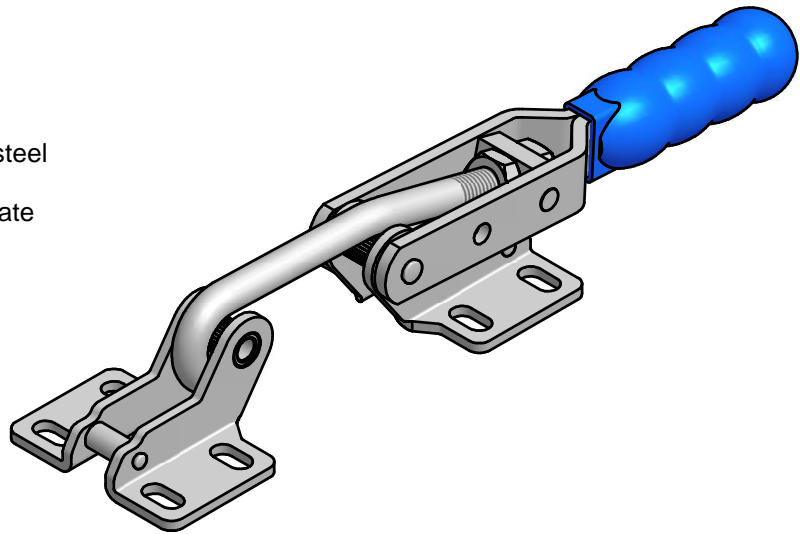

HC03SS
 Stainless steel
 option available