

# HOOK CLAMP

# HC27-SL



Clamps fitted with secondary safety lock

**Material:** Heavy gauge steel  
**Finish:** Zinc Plated  
**Supplied with:** Hook, Latch plate  
**Max holding force:** 710daN  
**Weight:** 0.77Kgs  
**Clamping pressure:**

HC27H-SL

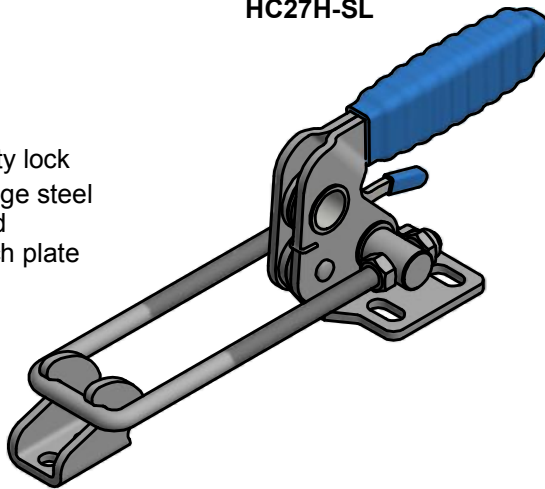

HC27V-SL

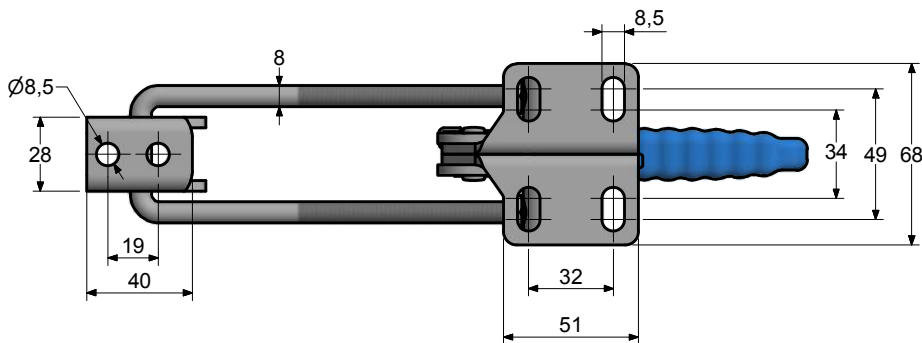
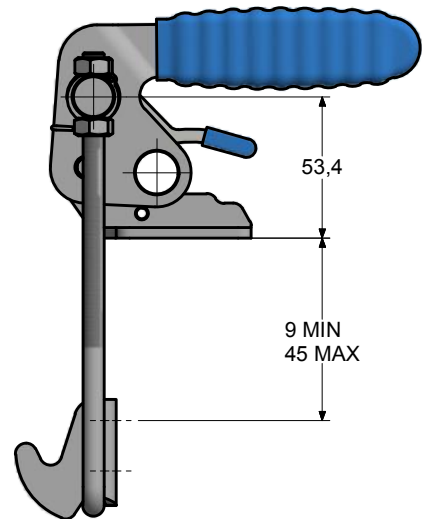
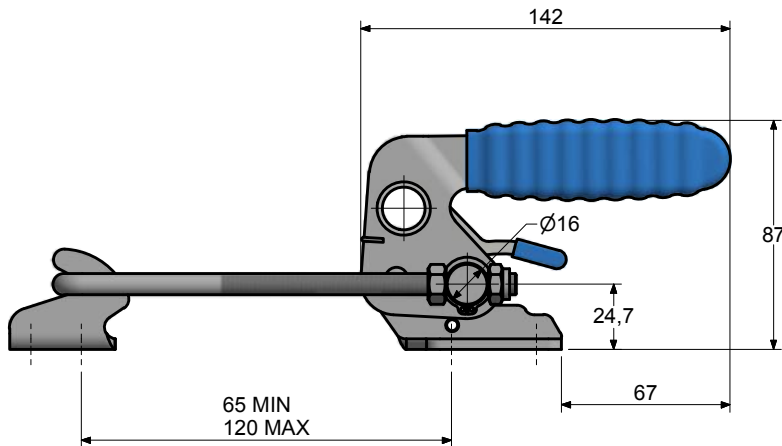
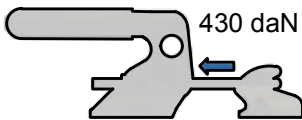
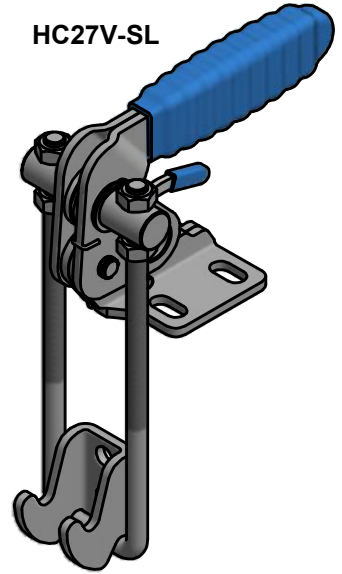

Different hook lengths available if required